



**EXTERIOR SHADES  
RETRACTABLE AWNINGS  
CERTIFICATION PRESENTATION**





**EXTERIOR SHADES  
RETRACTABLE AWNINGS  
CERTIFICATION PRESENTATION**



# Agenda

## LESSON 1 – Motorized Screens



- About Us
- Motorized Screens
- Plant Tours
- Dealer Appreciation Dinner

# Agenda

## Lesson 2 - Retractable Awnings



- Retractable Awnings
- Tech Talk Q&A



# Motorized Screens



## Use Case

Garage

Porch and Lanai

Recessed



## Mesh Discussion

Raw Material

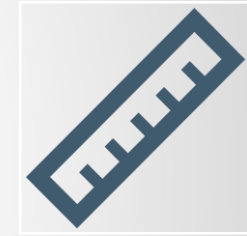

## Measuring Practices







# GARAGE DOOR SYSTEMS





- 
- Inside Under Mount
  - 4.5" Hood and Housing
  - Twitchell Nano 70



- 
- Inside Under Mount
  - 5" Hood and Housing
  - White Nano 50



- Outside Face Mount
- 5" Ivory Hood and Housing
- Suntex 80 Stucco





# PORCH OR LANAI SYSTEMS

(SOLAR)





- Standard Beige Hardware
- Retracted in Housing
- Bottom Bar Above Header
- Electrical Hidden







95 Alpaca







*Discount*  
**Blinds, LLC**



# PORCH OR LANAI SYSTEMS

(BUG SCREEN)







- 7" Hood and Housing
- White Hardware
- 132" Tuff Screen
- No Seem







WOOD DOCK  
& SEAWALL  
Phone: (941) 792-5322

**Discount  
Blinds, LLC**

Exterior view,  
hidden hardware



# PORCH OR LANAI SYSTEMS

(PRIVACY SCREEN)







- 7" Hood and Housing
- With Buildout







- Bronze Hood and Housings
- Sheerweave Blackout Material





# SA HURRICANE SYSTEMS / WIND ABATEMENT





# HURRICANE SCREENS

SA Tracks

5" or 7" Housings

Folded Hem

Omegatex Mesh

HD 2.5 Bottom Bar

Retention Pins





# RETENTION PINS







FOLDED HEM



# SA HURRICANE SYSTEMS VS. WIND ABATEMENT



# WIND ABATEMENT

VS

- Face Mount or Inside w/Angle
- No Retention Pins
- Standard Corner Gussets
- Currently Available

# HURRICANE

- Permit / Inspection Required
- Folded Hem 8'+
- Retention Pins
- Enhanced Corner Gussets
- Face Mount Only
- ETA Mid-November



# RECESSED SYSTEMS







*Discount  
Blinds, LLC*





*Discount  
Blinds, LLC*





*Discount  
Blinds, LLC*











# COMMERCIAL SYSTEMS





# Mattison's City Grille

- Suntex 95 Black
- Preferred for Rain, Solar & Temperature
- Preferred for Low Maintenance
- Full View





- Custom Sunbrella
- Shade Control
- Full View

- Suntex 95 Black
- Preferred for Rain, Solar & Temperature
- Preferred for Low Maintenance
- Full View







- Suntex 95 Dark Bronze
- Preferred for Temperature
- Preferred for Low Maintenance
- Full View







Inside View  
Commercial Tracks (NLA)







- Suntex 90 Dark Bronze
- Preferred for Solar
- Preferred for Low Maintenance
- Semi –Privacy Outside
- Commercial Tracks (NLA)







- Suntex 90 Dark Bronze
- Preferred for Solar
- Preferred for Low Maintenance
- Full View Inside
- Commercial Tracks (NLA)





# COMMERCIAL VINYL SYSTEMS







*Discount  
Blinds, LLC*



**Raw Bar**  
Thuddling & Bling  
Pud' Heal, King Cab, Margarita Madness  
Margarita Madness  
Blueberry - raspberry







- SA Track
- 4" Mullion Strip
- 50"x100" Clear Vinyl





# OPEN ROLLER 2.0 SYSTEMS





- ❖ Solar Blocking
- ❖ Suntex and Nano Solar Fabrics
- ❖ Sheerweave Fabrics
- ❖ Use with or without cables
- ❖ Optional Carport Style Hood
- ❖ All 5 Standard Colors
- ❖ Manual or Motorized
- ❖ 3" & 4" Roll Tubes
- ❖ Limited to 10' Fabric horizontal  
or vertical

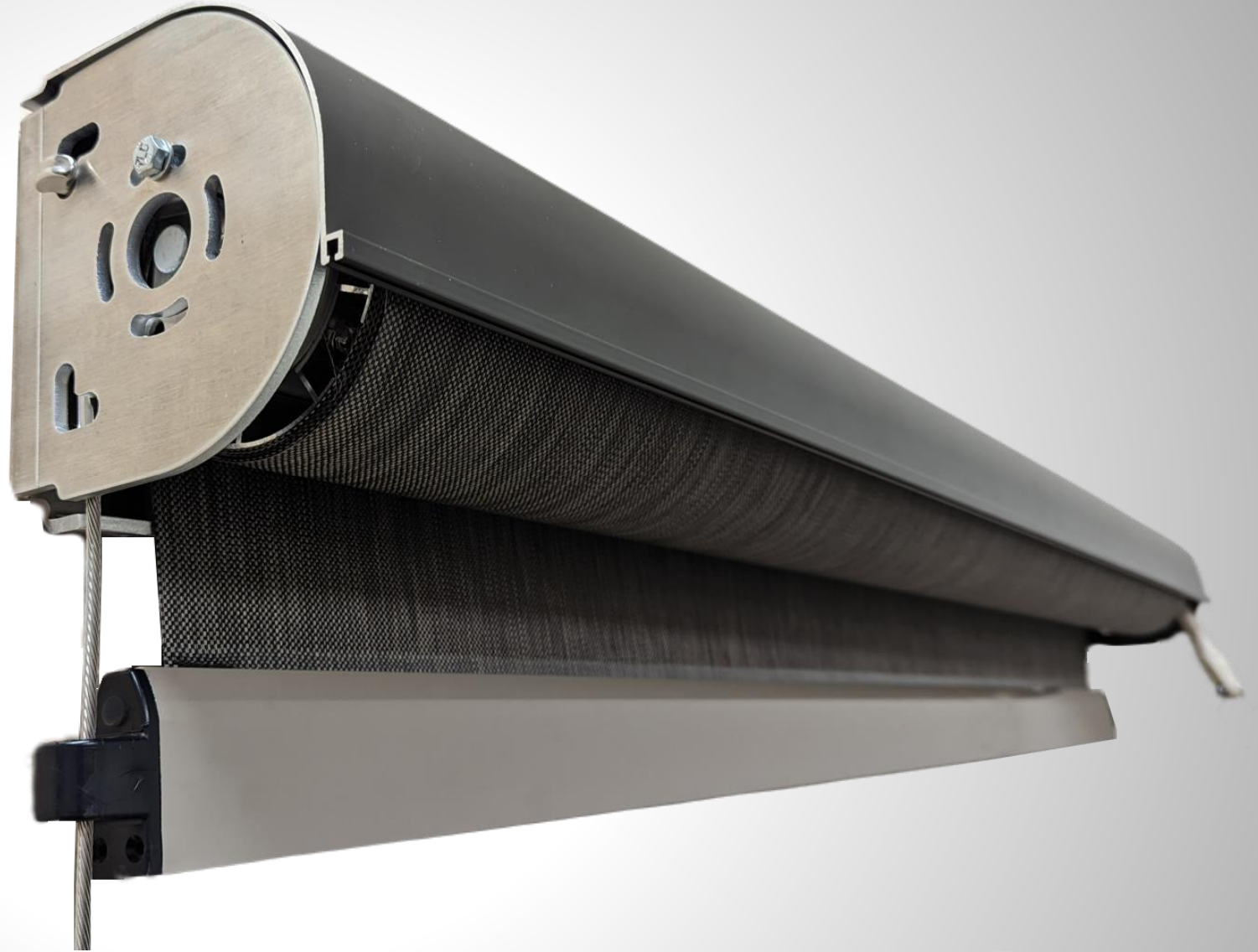



# NEW DOOYA LiOn MOTOR FOR OPEN ROLLER

- ❖ Built In LiOn Battery
- ❖ Solar Panel Charging
- ❖ AC Adapter Charging
- ❖ Both Chargers INCLUDED
- ❖ 20Nm / 10RPM

**DM45LE/S**  
 Built-in Lithium Battery  
 20Nm 10Rpm

12V  
DC

12V	Rated Torque (Nm)	Rated Speed (Rpm)	Rated Current (A)	Rated Power (W)	Degree of Protection (IP)	Maximum Limit Turn (turn)	Running Time (min)	Working Temperature (°C)	Length L1/L2 (mm)	Certification
DM45LE/S	20	10	4.1	50	IP44	45	>6	-10°C~50°C	758/725	CE





## Open Roller Cable Guided System

### Care and Use Disclaimer

The Open Roller Solar Screen is built to offer years of use while providing the solar blocking and privacy you are looking for!

**For the best results please note the following :**

1. Your new solar screen will acclimate to your environment. Leave your new screen down for the first 4 hours in direct sunlight to acclimate.
2. Open Roller systems do not have side tracks to tension the fabric. As such, waves in the fabric are to be expected.
3. Strong breezes and winds may cause the fabric to sail slightly. Do not use during high winds.
4. Open roller systems are not intended to protect against rain, bugs or other critters.
5. If your screen gets wet during rains, please allow the fabric to dry before rolling the unit back up to avoid potential mold or mildew growth on surface deposits trapped on your screen.
6. Always watch your screen as it goes up or down, and watch for obstacles that would prevent your screen from functioning fully. Do not leave moving screens unattended.
7. Clean with mild soap and water as needed, rinsing from the inside to the outside first. Heavy stains may be treated with a diluted bleach cleaner (10% or less), 303 Cleaner, or RMR-86 PRO.

- ✂
- I have been shown how to operate the Open Roller Screen
  - I have been told how to care for and maintain the screen, as well as the motorized unit
  - I am aware of the limitations of the Open Roller system
  - I have retained the contact details for my local Installing Dealer representative

Customer Name \_\_\_\_\_ Dealer Name \_\_\_\_\_  
Address \_\_\_\_\_ Dealer Phone \_\_\_\_\_  
City / State \_\_\_\_\_ Installer Name \_\_\_\_\_  
Signature \_\_\_\_\_ Date \_\_\_\_\_ Signature \_\_\_\_\_

1. Acclimate
2. No Sidetracks, expect waves
3. Do not use in high winds
4. Does not protect against rain / bugs etc
5. Allow screen to dry before rolling up
6. Do not leave moving screen unattended
7. Clean properly







- Solar or Privacy Fabrics
- 5 Hardware Colors
- Manual or Motorized
- With or w/o cables
- Optional Hood

Dimout White











- Solar or Privacy Fabrics
- 5 Hardware Colors
- Manual or Motorized
- With or w/o cables
- Optional Hood

**Discount  
Blinds, LLC**



# MOIRE EFFECT

- ❖ Moiré effect is a visual perception that occurs when viewing a set of lines or dots that is superimposed on another set of lines or dots, where the sets differ in relative size, angle, or spacing.

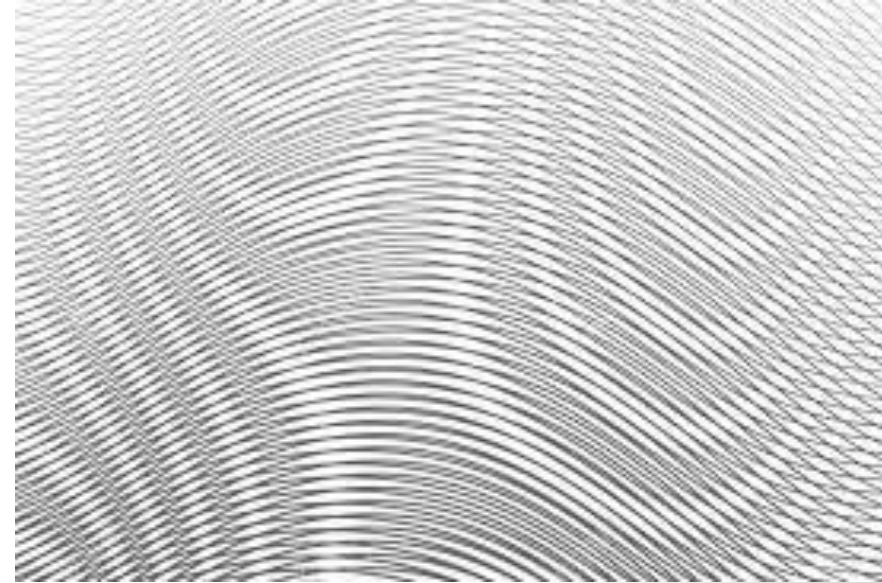



# SCREEN ONLY

- Replacement Screens for easy replacement
- Available to fit other manufacturers
- Custom Zipper and Keder Options





# INTERIOR SYSTEMS







**DOMETAG<sup>®</sup>**





# Polyurethane



The dome gives a raised or 3-D label look by using polyurethane.

We use polyurethane not epoxy.

Polyurethane

vs

Epoxy



## UV Test Results





## Adhesive

**Domed labels are 30x's heavier and thicker than a regular label.**

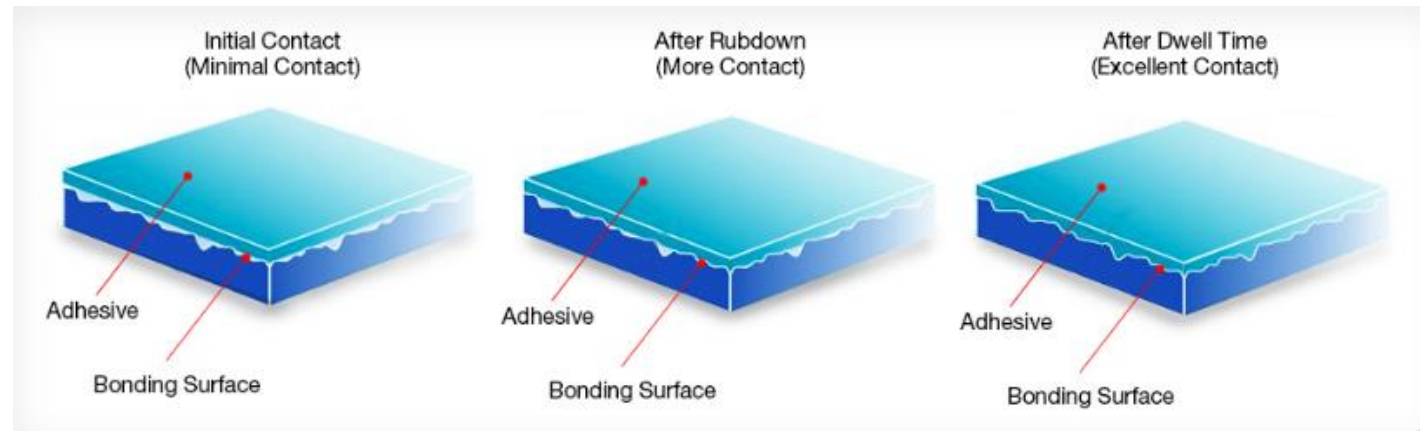

**Thicker adhesive is needed.**





# DOMETAG®



**Lance Garcia**  
Account Manager

801-972-4100 Ext. 1109  
Direct: 801-983-0144  
lance.garcia@dometag.com

3483 W 1500 S • Salt Lake City, UT 84104 • DomeTag.com

**Check us out**  
**[www.DomeTag.com](http://www.DomeTag.com)**



Motorized Screens Configurations

& Software Questions



# MEASURING & ORDERING DEDUCTIONS



- + 5" Standard Track Face Mount
- + 7" SA Track Face Mount
- - 1/2" Standard & SA Track Under Header
- - 0" Recessed Track (Inside to Inside Channel)
- Bias Cuts
  - None under 1/2"
  - Customer Expectations on Bias Cut

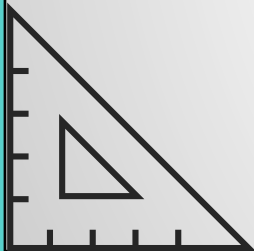



# HARDWARE OPTIONS



# Standard Colors



**White**  
Awnings, Roll Screens,  
Open Roller



**Ivory**  
Roll Screens



**Beige**  
Awnings, Roll Screens,  
Open Roller



**Black**  
Roll Screens



**Bronze**  
Awnings, Roll Screens,  
Open Roller





# Standard Track

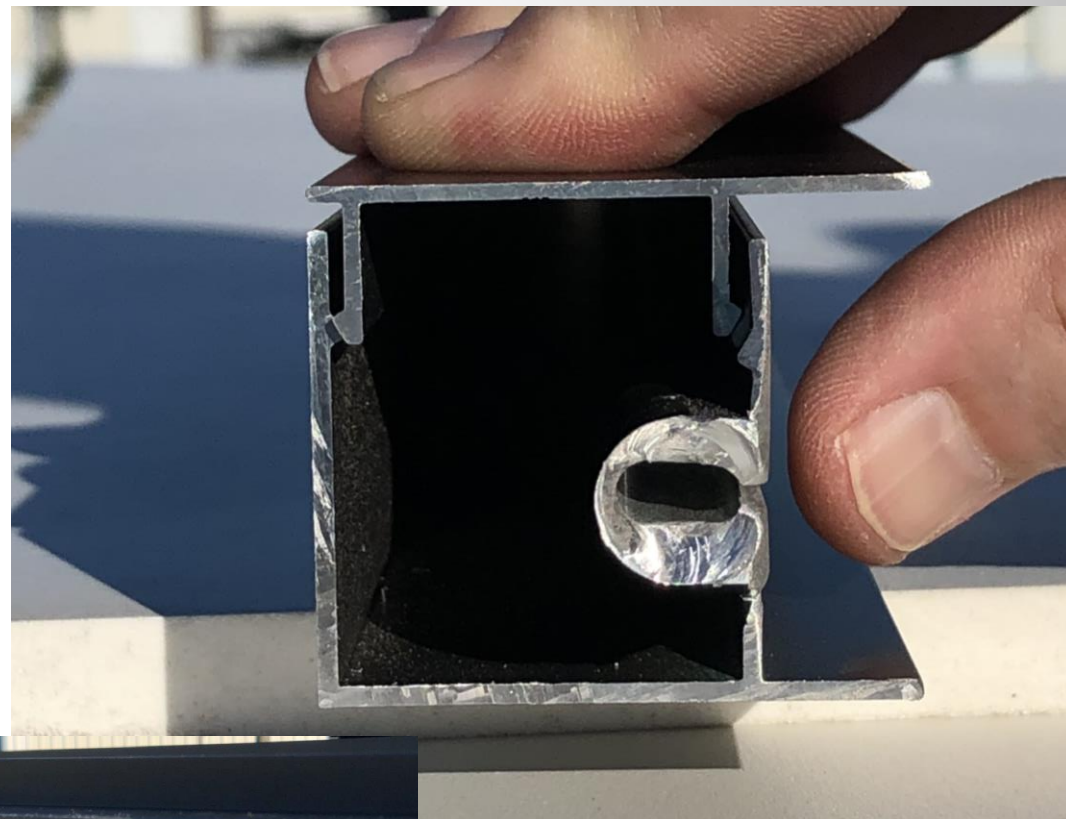
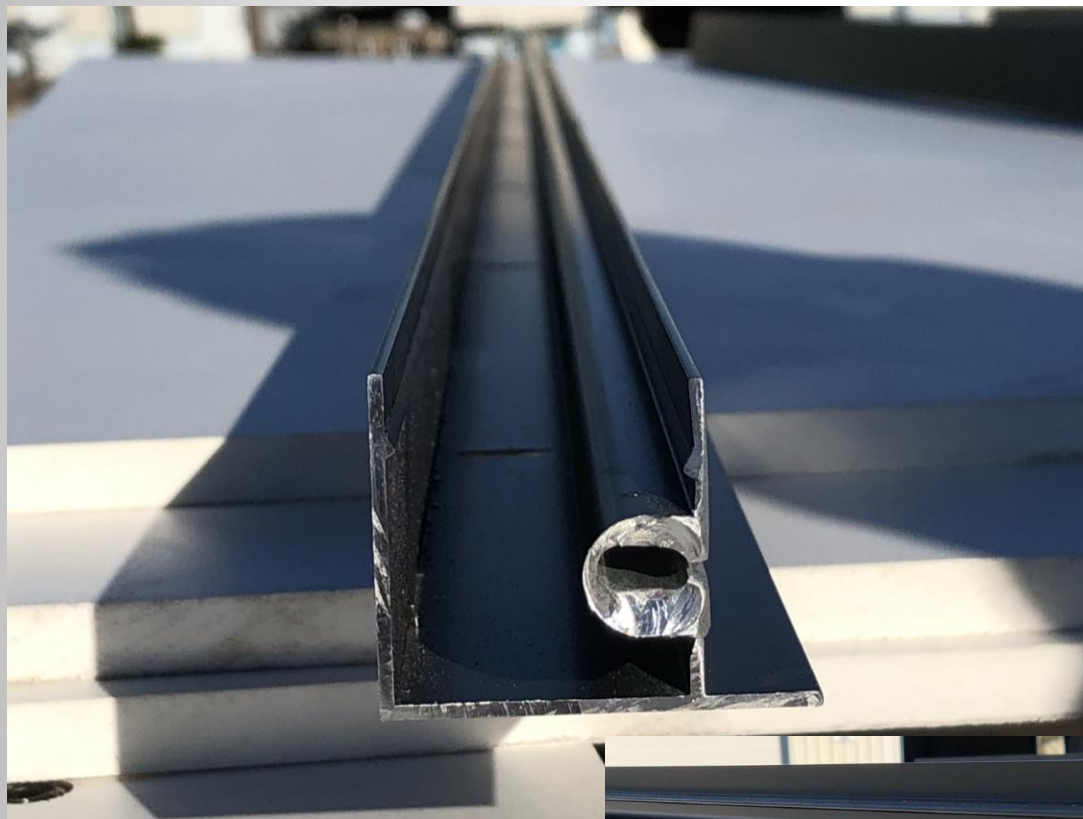

Track Punched

## New Standard Track Plug

Keep Bugs, Wasps, Frogs, and other critters out of the sidetracks! Great for windows and areas that the track does not rest on a ledge. Printed with UV and Chemical Resistant ASA media!



# Recessed Track

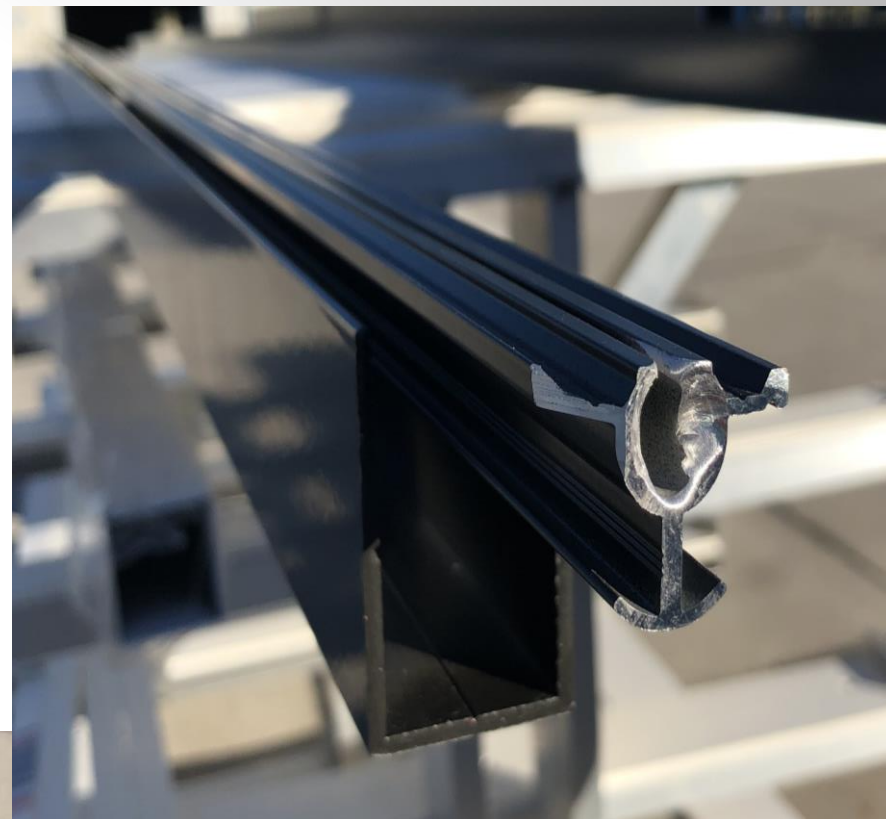
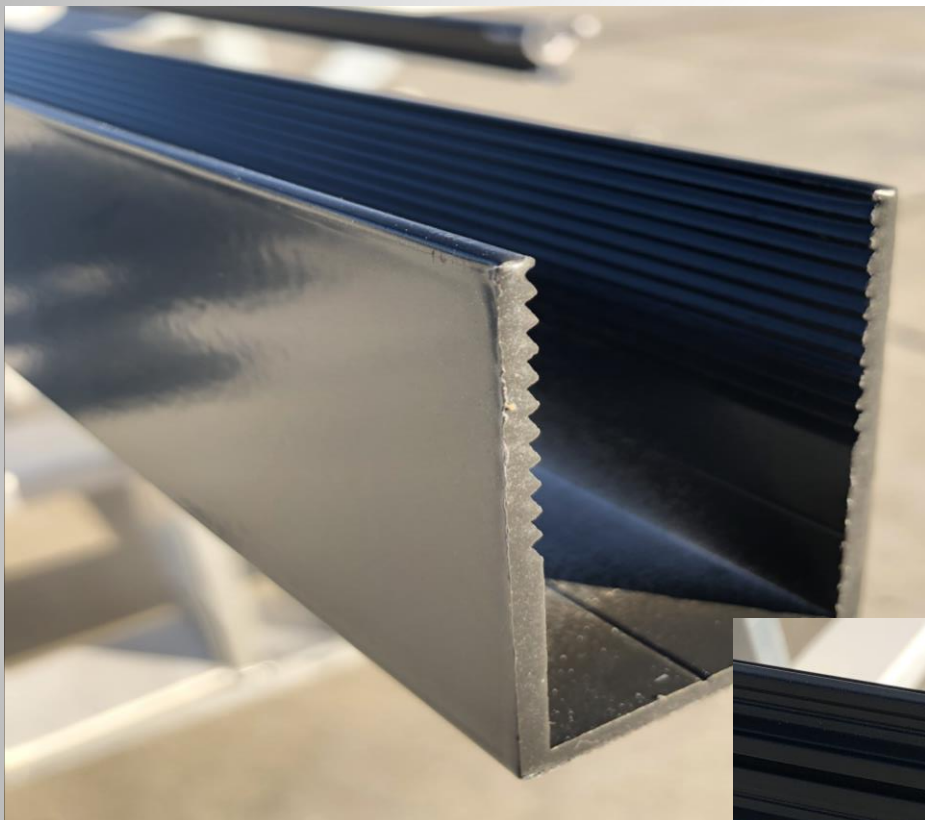

## SA Track Self Adjusting Track

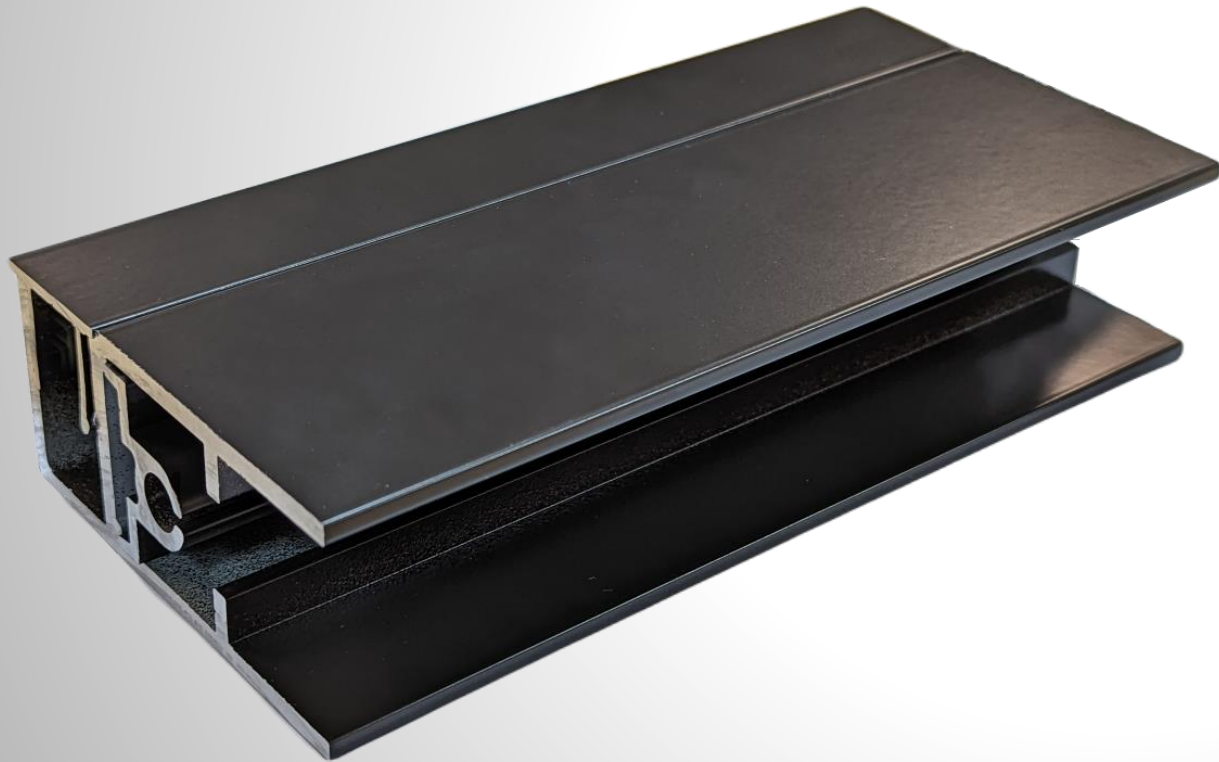

- Self Adjusting/ Self Tensioning
- Patent Pending Technology
- Superior Engineering
- Ideal for Vinyl Applications (as it adjusts for shrink & expansion)
- Engineered to be Hurricane Rated (Currently in Testing) - Now can be sold as a Wind Abatement Product
- Available as an option on any screen
- Will replace our commercial tracks





# SA Track Self Adjusting Track

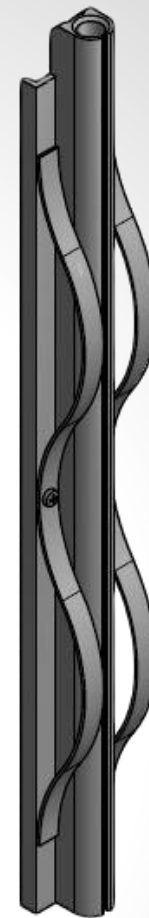
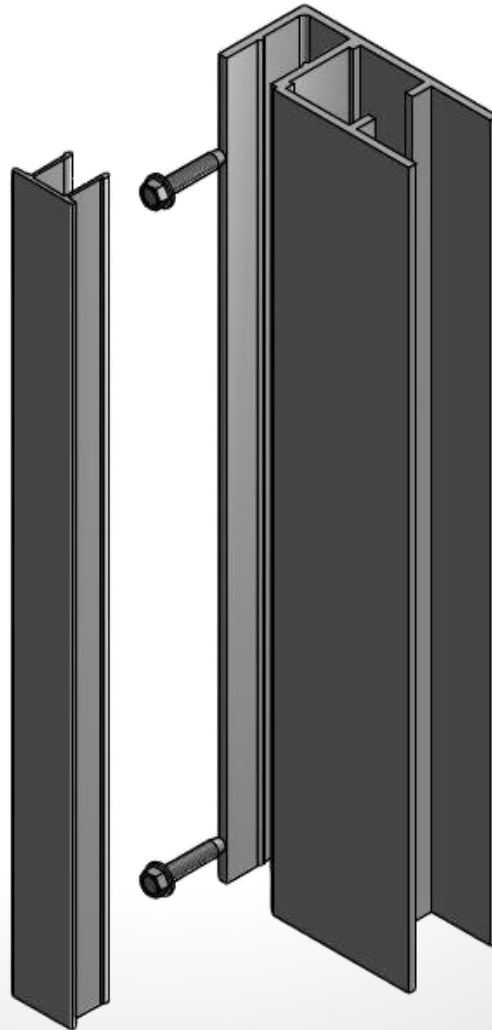
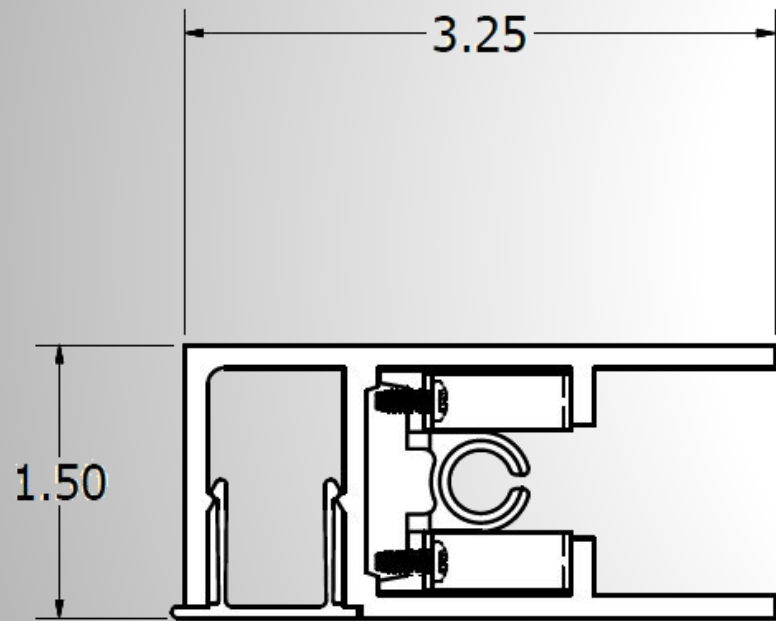

# Wind Abatement System

5.5" or 7.5"  
Housing

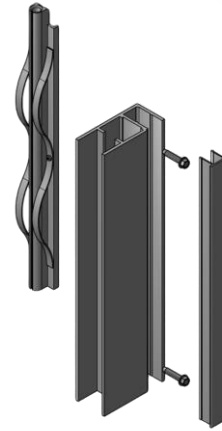

**SA**  
SELF-ADJUSTING  
TRACK SYSTEM

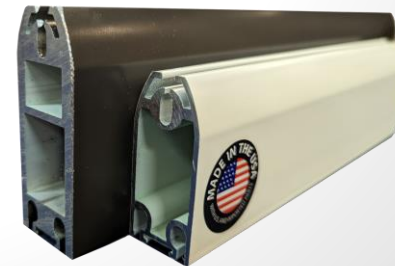

HD 2.5  
Bottom Bar





# Cable Guided

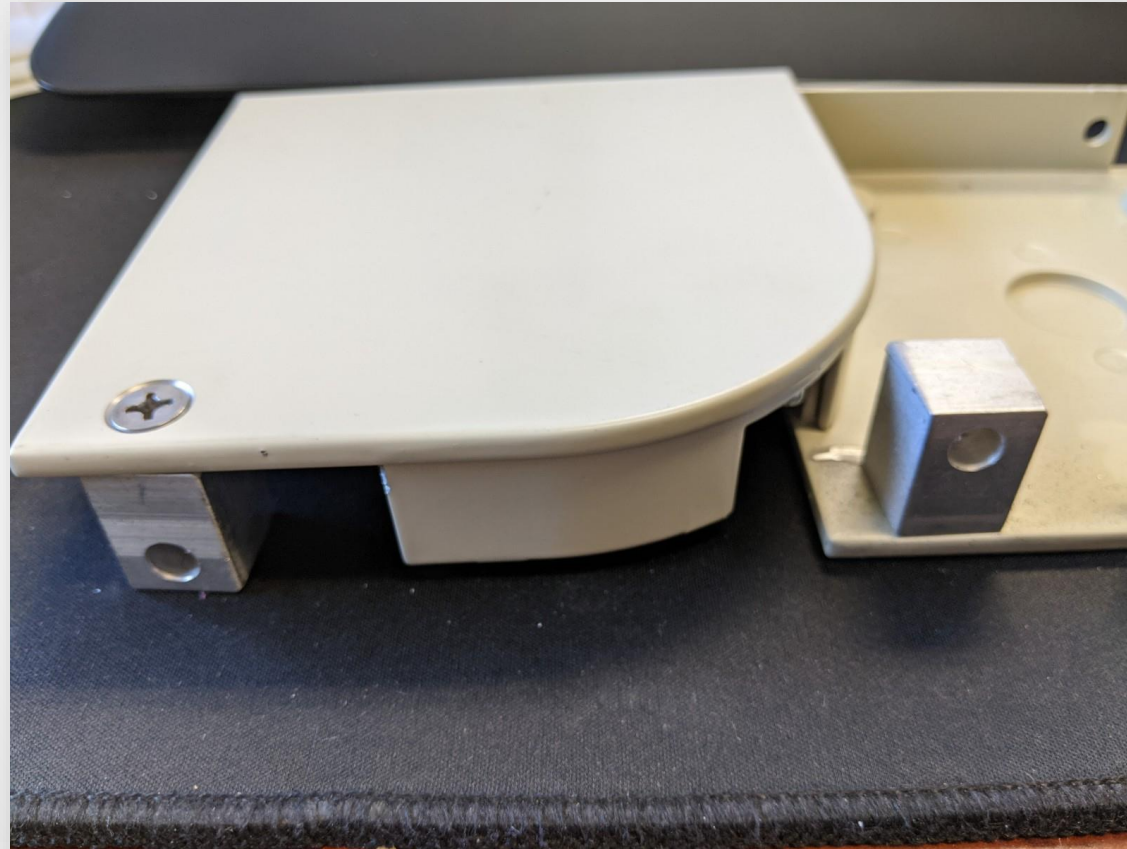

## Punches – Sidetrack vs Angle

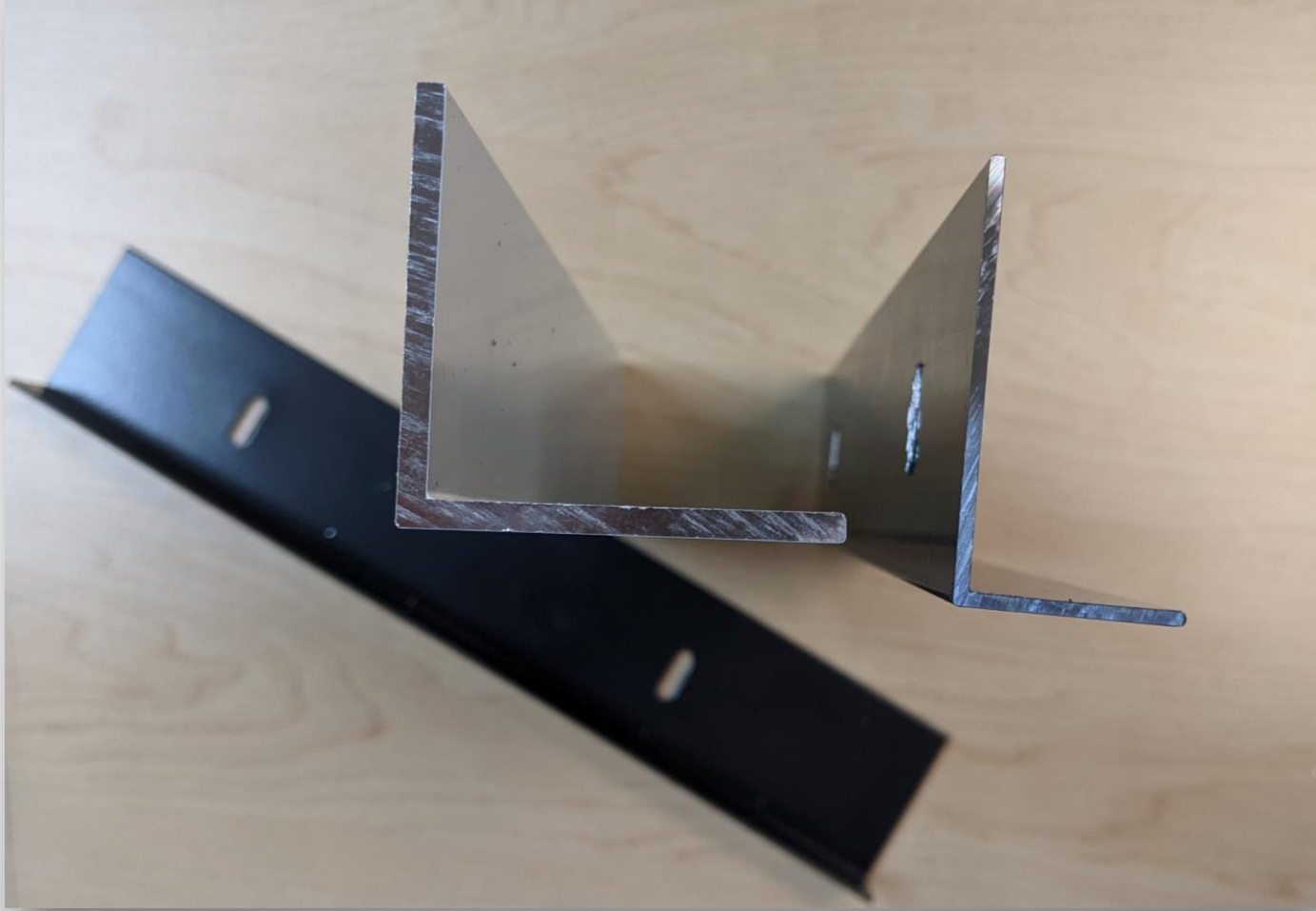



# Hood Sizes



## *New Bottom Bar HD 2.5 Option*

- ✓ Standard bar will still be default
- ✓ Reinforced bottom bar has a 68% reduction in horizontal deflection
- ✓ 3/4" Taller than standard bar
- ✓ Fits inside Standard & SA Tracks

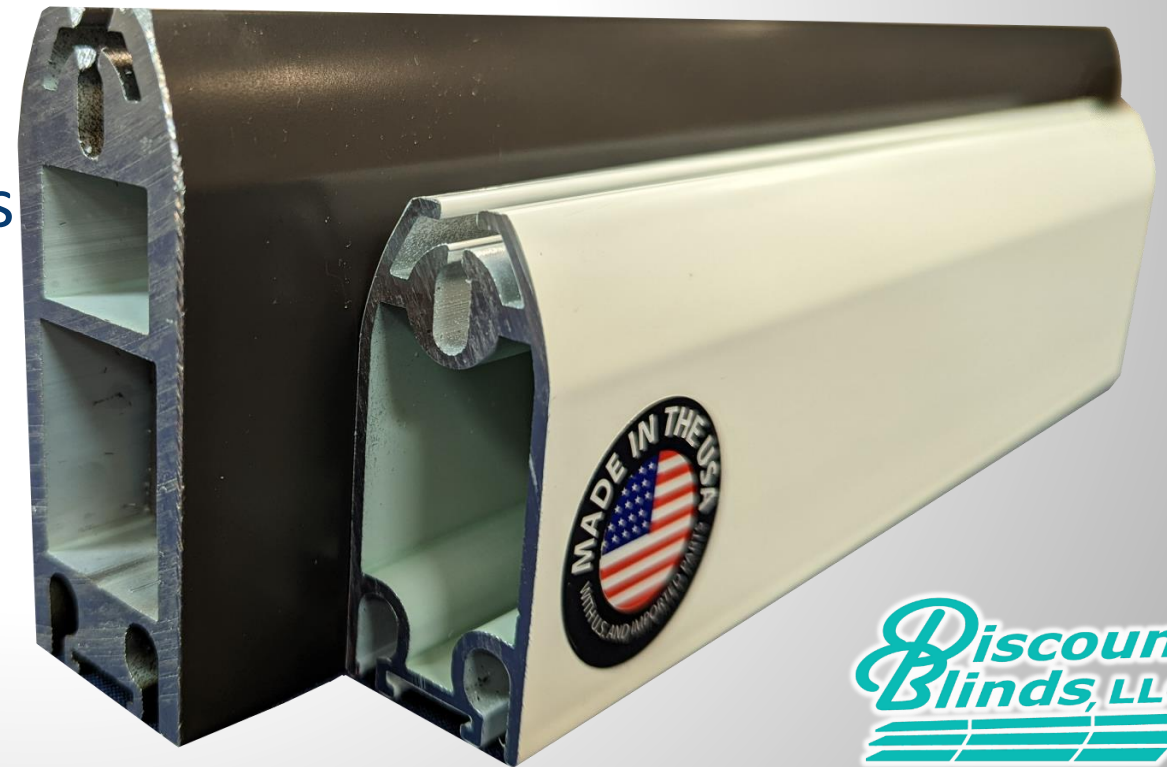



# Brush Seal Options



1.5" or 2" Black Brush

# Rubber Seal Options

BLACK ON WHITE

IVORY ON IVORY

BRONZE ON BRONZE

WHITE ON WHITE

GRAY ON WHITE

BLACK ON BLACK

BEIGE ON BEIGE





# Bottom Bar Weight

STANDARD WEIGHT



ADDITIONAL WEIGHT **INSIDE** THE BOTTOM BAR



ADDITIONAL WEIGHT **OUTSIDE** THE BOTTOM BAR



ADDITIONAL WEIGHT **INSIDE & OUTSIDE** THE BOTTOM BAR



Extra Weight Outside Bottom Bar N/A on HD 2.5 Bars

# HD 2.5 Bar vs Standard Bar

Example: 15' Wide Bottom Bar					
Bottom Bar Type	With No Weight added	Standard Weight	Additional Weight Inside	Additional Weight Outside	Additional Weight Inside & Outside
		<i>8.5 lbs each side</i>	<i>17 lbs each side</i>	<i>17 lbs each side</i>	<i>25.5 lbs each side</i>
<b>Total Weight Standard Bottom Bar</b>	<b>10.83</b>	27.83	44.83	44.83	61.83
<b>Total Weight HD 2.5 Bottom Bar</b>	<b>27.56</b>	44.56	61.56	61.56	78.56
Example: 20' Wide Bottom Bar					
Bottom Bar Type	With No Weight added	Standard Weight	Additional Weight Inside	Additional Weight Outside	Additional Weight Inside & Outside
		<i>8.5 lbs each side</i>	<i>17 lbs each side</i>	<i>17 lbs each side</i>	<i>25.5 lbs each side</i>
<b>Total Weight Standard Bottom Bar</b>	<b>14.44</b>	<b>31.44</b>	<b>48.44</b>	<b>48.44</b>	<b>65.44</b>
<b>Total Weight HD 2.5 Bottom Bar</b>	<b>36.74</b>	<b>53.74</b>	<b>70.74</b>	<b>70.74</b>	<b>87.74</b>
<i>Extra weight Charge</i>		<i>0</i>	<i>\$35.00</i>	<i>\$40.00</i>	<i>\$75.00</i>





# Screen Probes

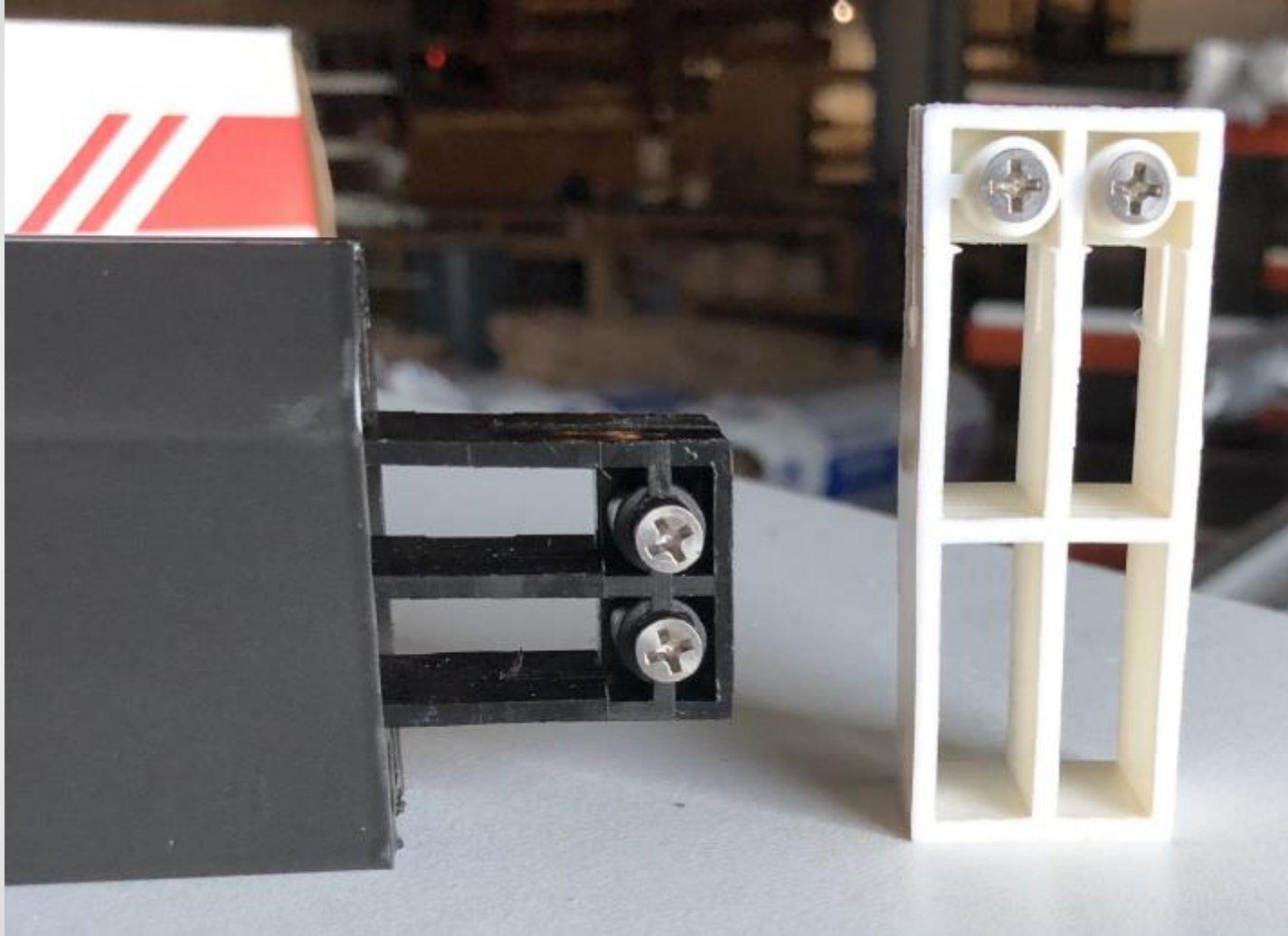

# MOTOR OPTIONS

DOOYA – SOMFY – SMART HOME AUTOMATION





**DOOYA**<sup>®</sup>  
TUBULAR MOTOR



**somfy**<sup>®</sup>



*Discount  
Blinds, LLC*

# NEW DOOYA ACCESSORIES FOR 2023

## Keychain Remote

- ✓ Single Channel
- ✓ Used in addition to a standard remote

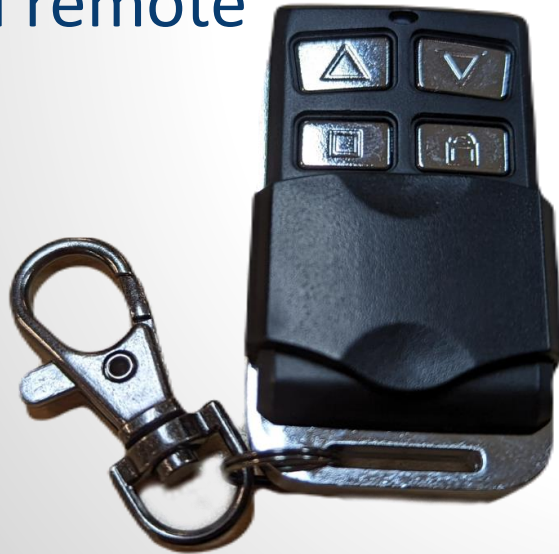

## Wind / Sun Sensor

- ✓ Control Up to 30 Screens
- ✓ Wind and Sun Control Options





## Dooya Accesories

- ✓ Single and 15 Channel Standard Remote
- ✓ Chrome Accented Removable Wall Remote
- ✓ Dooya Multi-Link Smart Home Connector Hub
- ✓ Keychain Remote
- ✓ Screen Wind Sensor

- ✓ Single, 5, and 15 Channel Water Resistant Patio Remote
- ✓ 4 Wire Hardwire Motor
- ✓ Gang Box Mounted Hardwire Switch
- ✓ TaHoma Smart Home Hub
- ✓ Screen Wind Sensor



## Dooya vs. Somfy

**DOOYA**<sup>TM</sup>  
TUBULAR MOTOR

- Multi-Attempt obstacle detection
- One single or 15 channel remote provided
- Simple programming
- Smart home hub available
- 3<sup>rd</sup> Party integration clunky but available
- No US Customer Service Line
- Lowest failure rate
- Costs Less
- Interior shade motors in development

**somfy**<sup>®</sup>

- Single attempt obstacle detection
- Must purchase 1, 5, or 15 channel remote
- More in-depth programming
- Smart home hub available
- Integrates well with 3<sup>rd</sup> party apps
- Multiple US based Customer service centers
- Slightly higher failure rate
- Higher initial cost
- Ties in with other Somfy units such as interior shades

# Smart Home Automation

**DOOYA**<sup>®</sup>  
TUBULAR MOTOR

Multi-Link Connector



 **bond Bridge**



**somfy**<sup>®</sup>

Tahoma Gateway



*Discount  
Blinds, LLC*



## RTS – Radio Technology Somfy

- Built-in RF remote control
- Plug & play
- 12 memory slots
- 65' Range
- 18" Antenna (in the cable)
- Visual confirmation
- "MY" Favorite position
- UL and FCC Approved



# DecoFlex WireFree Wall Switch™ RTS

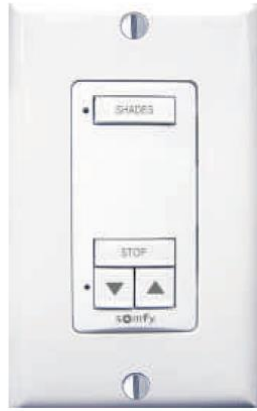

1 Channel Button  
DecoFlex WireFree™ RTS  
(WHITE)



2 Channel Button  
DecoFlex WireFree™ RTS  
(BLACK)



3 Channel Button  
DecoFlex WireFree™ RTS  
(IVORY)

Quick and Easy Personalization

Removable Channel Buttons



Switch Base Assembly



Removable Face Plate  
(3 channel button shown)



Wall Plate

Choose from the options below:

### Channel Buttons

KITCHEN	BATHROOM	FOYER	OFFICE	SHADE	SHADE 1	SHADE 2
BEDROOM	DINING RM	SUN ROOM	LIVING RM	SHADES	SHADE 3	SHADE 4
GREAT RM	BALCONY	PATIO	DECK	BLIND	BLIND 1	BLIND 2
AWNING	BLACKOUT	SHEER	SKYLIGHT	BLINDS	BLIND 3	BLIND 4
WOVEN	DRAPERY	ALL	GUEST RM	SHUTTER	SHUTTER 1	SHUTTER 2
LOBBY	THEATER	HEATER	ROMAN	SHUTTERS	SHUTTER 3	SHUTTER 4
STUDY	LANAI	DEN	LIGHTS	SCREEN	SCREEN 1	SCREEN 2
MASTER	MORNING	NIGHT	NURSERY	CONF. RM	SCREEN 3	SCREEN 4

### Command Buttons:

Note: The Open and Close buttons are for use with interior window covering, exterior solar screens/shade, and rolling shutter applications. They are not for use with awning applications.



### DECOFLEX RTS

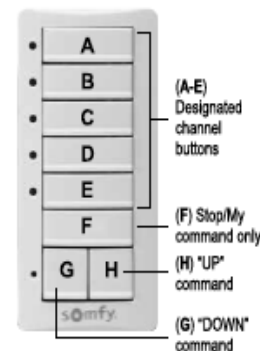

### Buttons (A-F)

9 Characters Maximum (including spaces)

Qty.

Buttons (A-F)	9 Characters Maximum (including spaces)	Qty.
A	<input type="text"/>	<input type="text"/>
B	<input type="text"/>	<input type="text"/>
C	<input type="text"/>	<input type="text"/>
D	<input type="text"/>	<input type="text"/>
E	<input type="text"/>	<input type="text"/>
F*	<input type="text"/>	<input type="text"/>
G	<input type="text"/>	<input type="text"/>
H	<input type="text"/>	<input type="text"/>



# TaHoma®

## Interior Smart Shading



Blinds



Cellular



Drapery



Roller

Comfort

## Exterior Smart Shading



Awning



Exterior Screens



Pergola

Energy Savings

Privacy & Security

## Smart Living & Security



Rolling Shutter



Lights

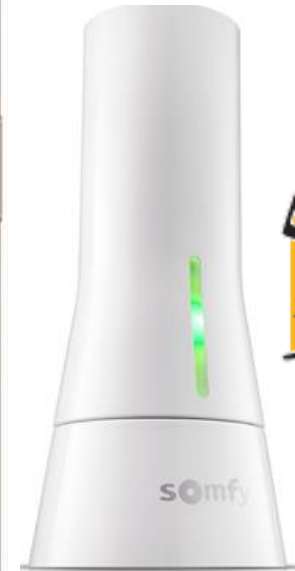

1811731



A Smart, Seamless, Secure, and Open platform



Radio Technology Somfy®



# TaHoma RTS: Smart Home Compatibility

LEADING CONSUMER BRAND PLATFORMS

GOOGLE ASSISTANT



AMAZON ALEXA



IF THIS THEN THAT

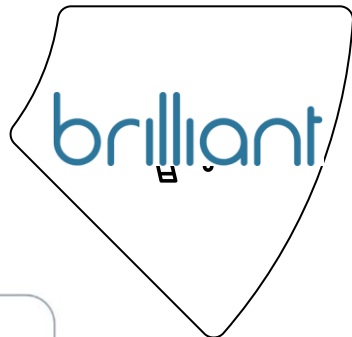
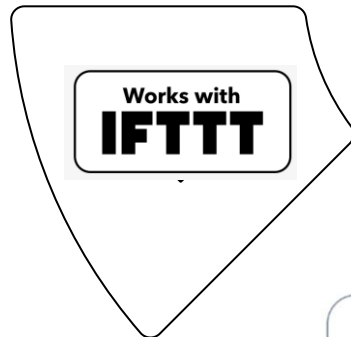
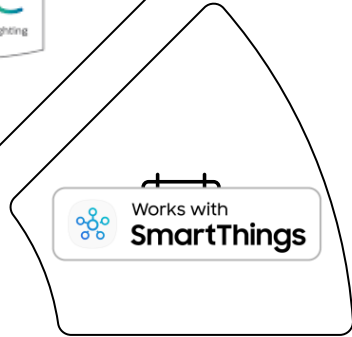
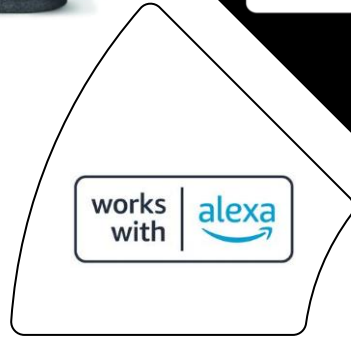

PHILIPS HUE



SAMSUNG SMARTTHINGS



BRILLIANT



TaHoma®



# TaHoma RTS: Certified Home Automation Integrations

LEADING HOME AUTOMATION PROVIDERS

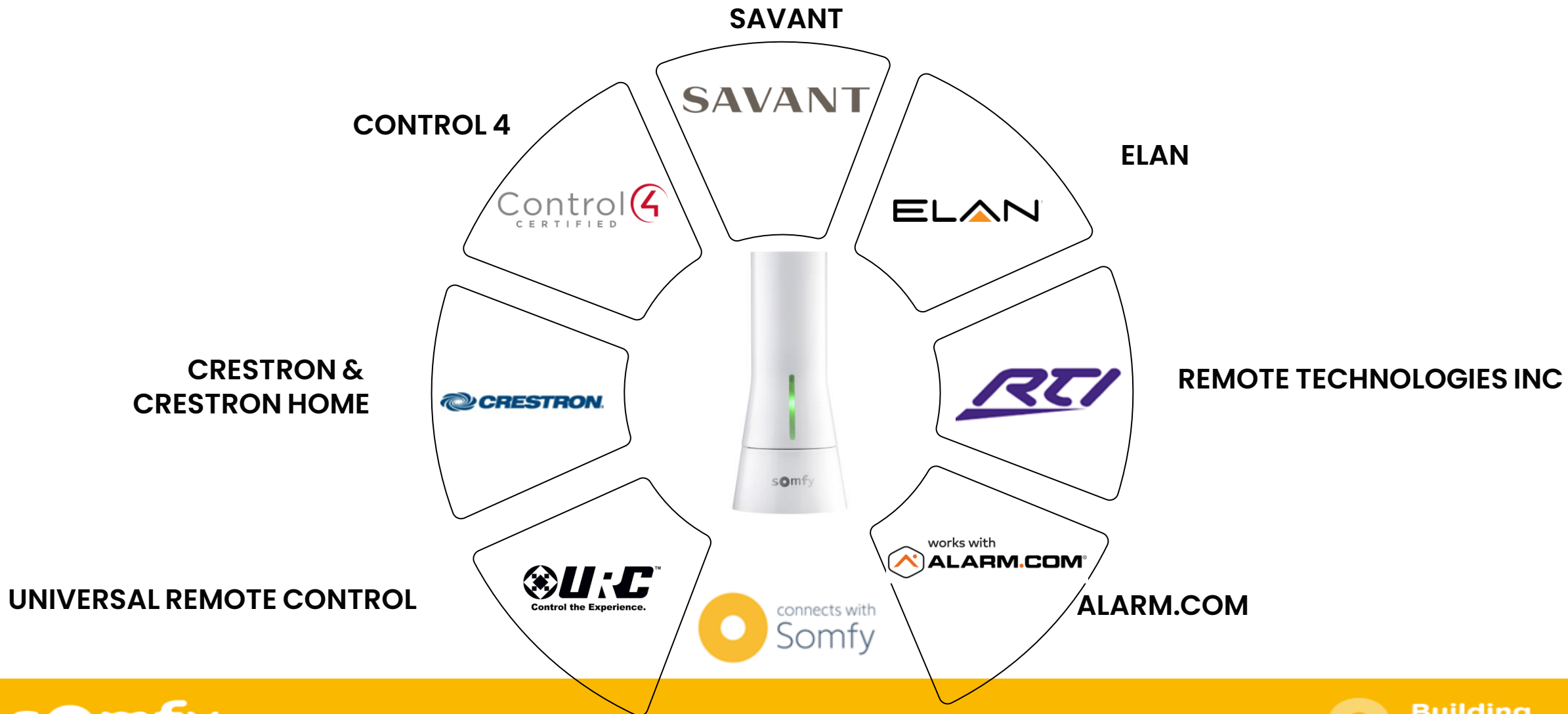

SOMFY PRESENTS

# Help Me

Help Me by Somfy is an application that guides you step-by-step when installing Somfy products. Now there's no need for paper manuals, regardless of your project.

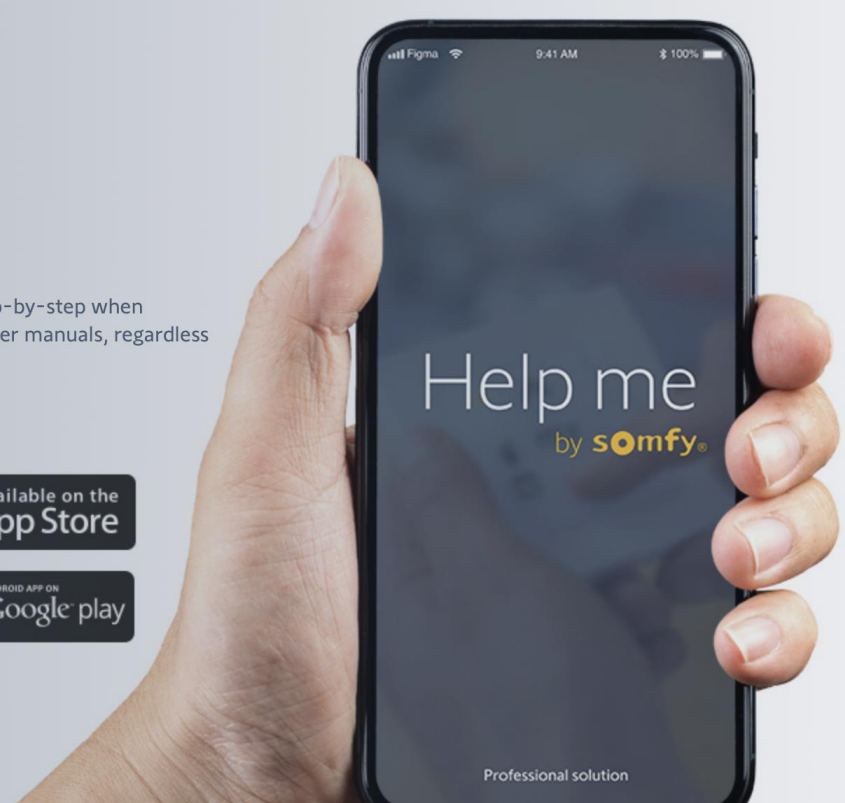
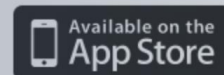

## 4 GOOD REASONS TO USE HELP ME



An intuitive and image-based step-by-step guide



Favorite your most used configuration and recall anytime



Access to instructions even without an Internet connection



Installation instructions for all Somfy products in your pocket



How to determine  
motor side



## Zipper or Keder

Zipper/Keder Color

---

Color

- Black
- White





# FABRIC OPTIONS

SOLAR, PRIVACY, INSECT, VINYL





Nano 50 Black or White  
Nano 70 No See Um Black  
Nano 95 (10 Colors)  
Nano 97 (5 Colors)  
Nano 99 (5 Colors)  
Omegatex (4 Colors)  
Dimout (8 Colors)



Tuff Screen Black  
Tuff Screen NoSeeUm BLK  
Suntex 80 (7 Colors)  
Suntex 90 (7 Colors)  
Suntex 95 (10 Colors)  
Suntex 97 (2 Colors)  
Shearweave (11 Colors)



Weblon (34 Colors)  
Sunbrella (30 Colors)  
Strattaglass 50" x 100"





# Roll Heights and Seams

Screen Category	Screen Manufacturer	Screen Item	Color	Roll Height
Insect Screen	Phifer	Black Tuff Screen	Black	132
Insect Screen	Phifer	Black Tuff Screen No See Um	Black	132
Insect Screen	Twitchell	Nano 50	Black	144
Insect Screen	Twitchell	Nano 50	White	120
Insect Screen	Twitchell	Nano 70	Black	126
Solar	Phifer	Suntex 80	Except Grey & Beige	120
Solar	Phifer	Suntex 80	Grey & Beige	96
Solar	Phifer	Suntex 90	Except Grey	120
Solar	Phifer	Suntex 90	Grey	96
Solar	Phifer	Suntex 95	All Colors	126
Solar	Twitchell	Textilene 80/90	White	126
Solar	Twitchell	Dimout	All Colors	120
Solar	Phifer	Shearweave 1%	All colors	126
Solar	Phifer	Blackout	All Colors	96
Solar	Twitchell	Nano 95/97/99	All Colors	126
Hurricane Screen	Twitchell	Omegatex	All Colors	126

Mesh

Mesh Manufacturer

Phifer Twitchell

What brand?

Suntex 80 Suntex 90 Suntex 95 Suntex 97 Shearweave

What color?

All Suntex 90 Roll Heights are 120" with the exception of Grey which is 96"

Beige Black Brown Dark Bronze Grey Stucco

Warning: The Roll Height on this fabric is 96"

Review

## How do Roll Heights affect Seams?

- Roll Height = Seam Height (with minor offsets – Bottom Bar & ½ Hood/Housing height)
- If all screens' widths are under Roll Height, then “Railroading” is an option
- System will warn when fabric height is below 120



# Screen Mounting

Face Mount (Surface Mount)

Under Header Mount (Inside or Trapped Opening Mount)

Recessed Mount

Double Recessed Mount



---

Motor Replacement

---

Fabric Replacement

---

Idler Replacement

---

Adding external weight

---

Re-Wraps

---

Cleaning

---

Lubrication

# Warranty Information

	Component	2 Year	5 Year	10 Year	15 Year	Lifetime
<b>Hardware</b>						
	Extrusions					X
<b>Electronics</b>						
	Dooya Motor Controls		X			
	Dooya Remotes		X			
	Dooya Multi-Link		X			
	Somfy Motor Controls		X			
	Somfy Remotes		X			
	Somfy Mylink / TaHoma		X			
<b>Fabrics</b>						
	Pfifer Bug Screen			X		
	Phifer Suntex Solar			X		
	Phifer Sheereweave			X		
	Twitchel Bug Screen				X	
	Twitchel Nano Solar				X	
	Twitchel DimOut				X	
	Weblon Vinyl		X			
	Ferrari Soltis		X			
	Strattaglass Clear Vinyl	X				
	Omegatex				X	





# AWNING SYSTEMS

# Product Line-up – Retractable Awnings

## Custom Frame Sizes – Widths from 9'6" – 40'

Three Standard Projections Sizes available (8', 10' & 12')

Three Popular Frame Colors Available (White, Bronze & Beige)

30 in-stock Sunbrella Fabrics (Special order available for slight upcharge)

Most Standard Premium Features in the industry!:

1. LED lights integrated into the arms
2. Cassette housing (garage vs. car port)
3. EZ adjustable pitch (huge differentiating feature)
  - Motorized with remote (including light on low / high and off)
  - 10-year non-prorated warranty on everything (including fabrics)
  - Your choice straight valance or sea wave included
  - Fantastic Fit & Finish
  - Multiple motor options





# PREMIUM FEATURES—STANDARD ON EVERY AWNING FROM SUNPRO

**CUSTOM FRAME SIZES**  
Widths from 10' up to 40'.  
Three standard projection  
sizes available (8", 10" & 12").

**FANTASTIC FIT & FINISH**  
Give your awning a high-end  
look at a great value.

**10 YEAR WARRANTY**  
SunPro is committed to long-  
term customer satisfaction.



① Built-in, Dimmable LED Lights

② Choose Straight or Sea Wave valance style

Sea Wave

Straight

③ EZ-Pitch Adjustment to raise and lower the pitch to defend against the sun or to allow rain runoff

④ Integrated Cassette Housing provides greater protection from the elements and longevity of the fabric

⑦ Three popular frame colors

White

Bronze

Beige

⑤ Multi-use front bar to accommodate optional accessories

⑥ All motorized with wireless remote and manual (crank) override



Integrated LED lights on Arms





# CROSS ARM AWNING SYSTEM



- ◆ 8' up to 13'5" width
- ◆ 12' Projection
- ◆ Full Semi-Cassette Housing
- ◆ Integrated LED Lights
- ◆ Premium **Sunbrella** Fabric



# RETRACTABLE AWNING CONFIGURATIONS



# DIMENSIONS

## How to Measure for a Retractable Awning

- Minimum Height Requirement is 7'6"
- If installing above a window or door – need a minimum of 10"
- Recommend for Shade not for outdoor space

## Projection

(Limitations of a Lateral Arm Awning)

- 8' must be a minimum of 9'6"
- 10' must be a minimum 11'6"
- 12' must be a minimum of 13'6"

## Over 20' Awnings

- More than 2 arms start at 21'

Powered Lifts available with SunPro discount





**FRAME COLORS**



**White**

Awnings, Roll Screens,  
Open Roller



**Bronze**

Awnings, Roll Screens,  
Open Roller

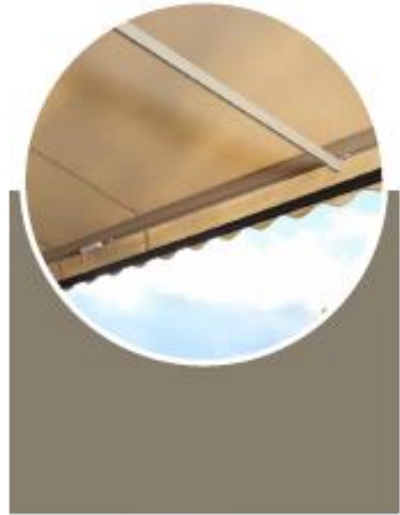

**Beige**

Awnings, Roll Screens,  
Open Roller



# *SUNBRELLA AWNING FABRICS*



- 30 Most popular Sunbrella colors **IN STOCK** available at no extra charge
- Custom Sunbrella fabrics available for a slight upcharge (Upcharge is 10% of awning total wholesale price)







**Sunbrella Shade  
Fabrics: Long-  
Lasting Comfort &  
Style.**







## Most Trusted & Preferred by Homeowners

Based on a 2020 third-party study among U.S. households with incomes greater than \$100k.



LIMITED WARRANTY

## Most Comprehensive Warranty

Backed by the industry's most comprehensive 10-year warranty, now including labor costs. See [sunbrella.com/warranty](http://sunbrella.com/warranty) for full warranty details.



## Sunbrella Care Team

Our dedicated Sunbrella Care Team is standing by, ready to answer your customers' care and cleaning questions.



## Long-Lasting

Stain, mold and mildew resistant, providing lasting durability no matter the environment.



## Fade & UV Resistant

Won't fade or become damaged due to the sun's harsh rays or normal wear.



## Easy Care, Bleach Cleanable

Low maintenance and easy to clean when needed—even with bleach.



## Award-Winning Design

Sunbrella designers draw on a depth of expertise and a keen understanding of design trends to create fabrics that your customers want.

## Supply Chain Management

Sunbrella controls its supply chain to ensure the highest quality every step of the way.



# SHADE STUDIO

<https://shadestudio.sunbrella.com/sunpro/>

Special SunPro version of Sunbrella's Shade Studio available to all SunPro Dealers.

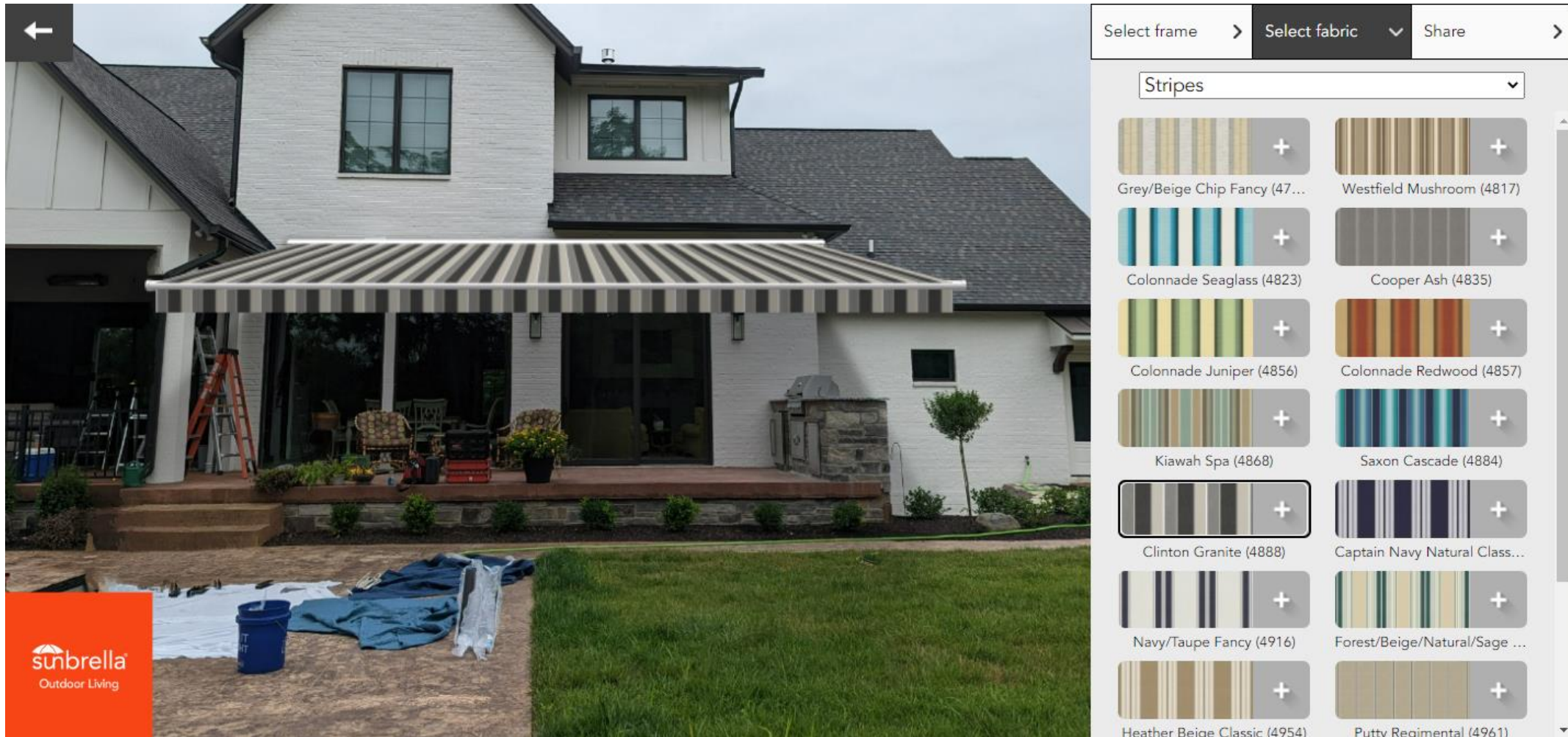

The image shows a screenshot of the Sunbrella Shade Studio interface. On the left, a photograph of a white house with a striped awning over the porch. On the right, a selection menu titled "Stripes" is displayed. The menu includes a "Select frame" dropdown, a "Select fabric" dropdown, and a "Share" button. Below these are 18 fabric pattern options, each with a small preview and a "+" icon. The "Clinton Granite (4888)" option is highlighted with a black border. The Sunbrella logo is visible in the bottom left corner of the screenshot.

Frame	Fabric
Stripes	Stripes
+	Grey/Beige Chip Fancy (47...)
+	Westfield Mushroom (4817)
+	Colonnade Seaglass (4823)
+	Cooper Ash (4835)
+	Colonnade Juniper (4856)
+	Colonnade Redwood (4857)
+	Kiawah Spa (4868)
+	Saxon Cascade (4884)
+	Clinton Granite (4888)
+	Captain Navy Natural Class...
+	Navy/Taupe Fancy (4916)
+	Forest/Beige/Natural/Sage ...
+	Heather Beige Classic (4954)
+	Putty Regimental (4961)





# FABRIC

<https://shadestudio.sunbrella.com/sunpro/>

Special SunPro version of Sunbrella's Shade Studio available to all SunPro Dealers.

- SunPro 30 in-stock Sunbrella Fabric Colors – Preloaded
- SunPro Hardware Colors Preloaded

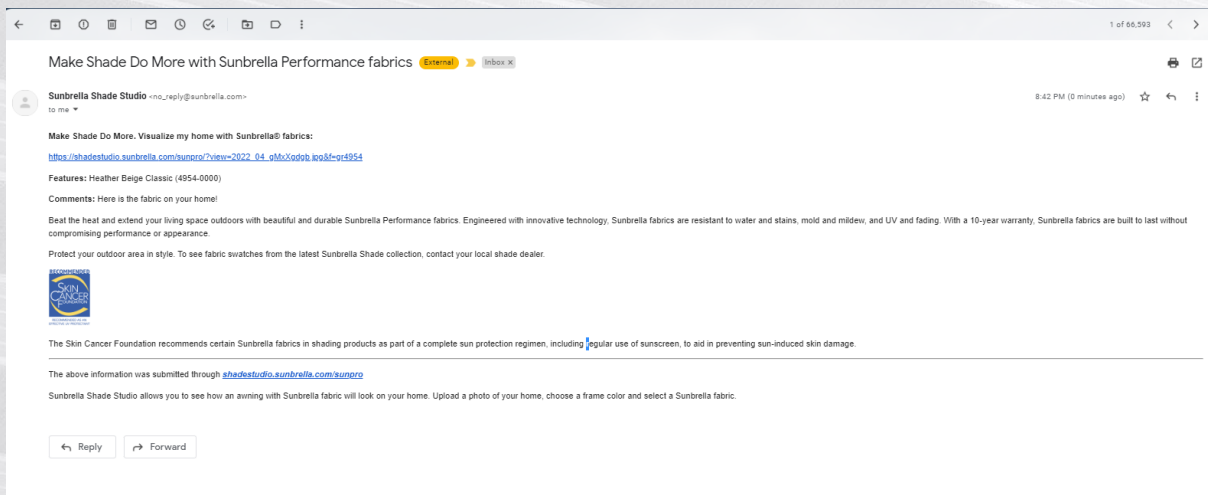
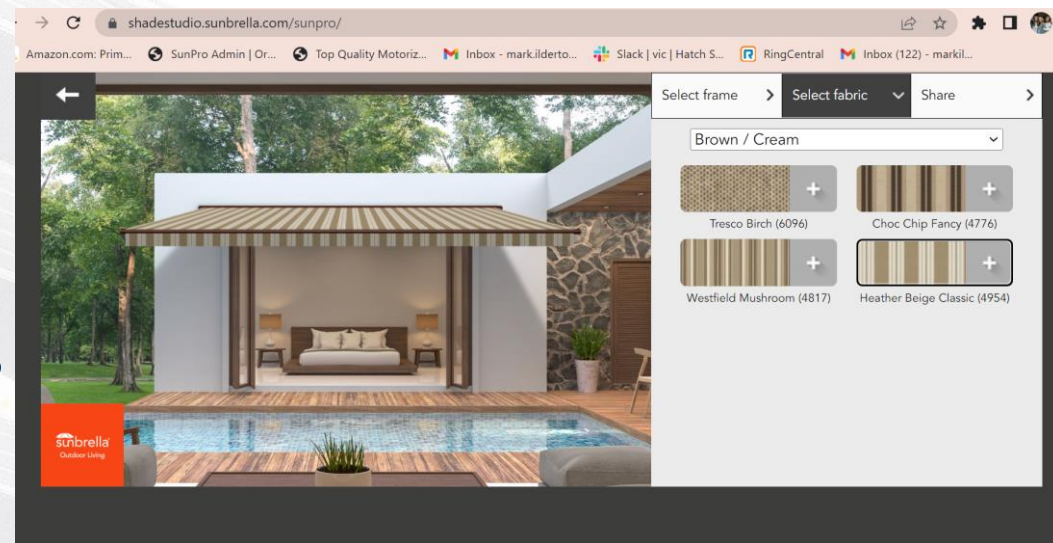

SUNBRELLA FABRICS

NEW 2023 SUNBRELLA FABRICS



sunbrella®





**Paxton Dew**

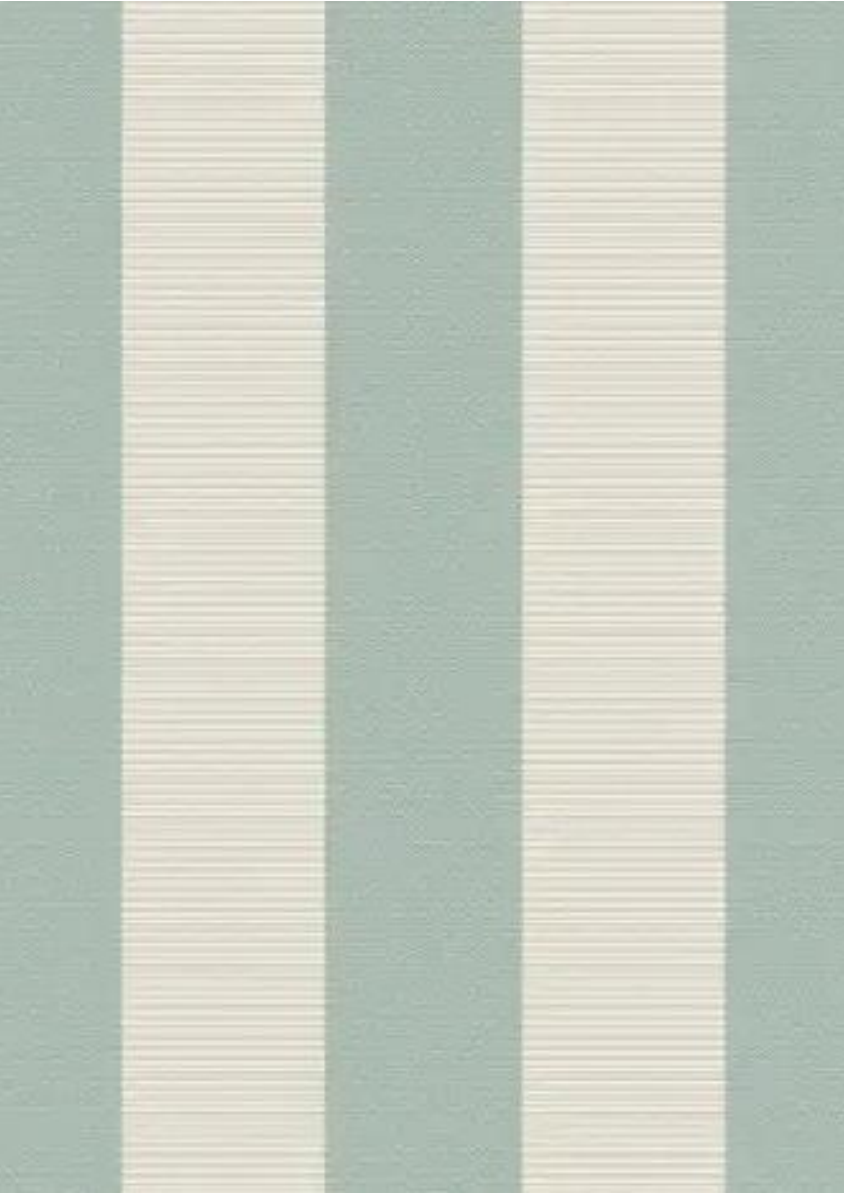

**Equate Cashmere**

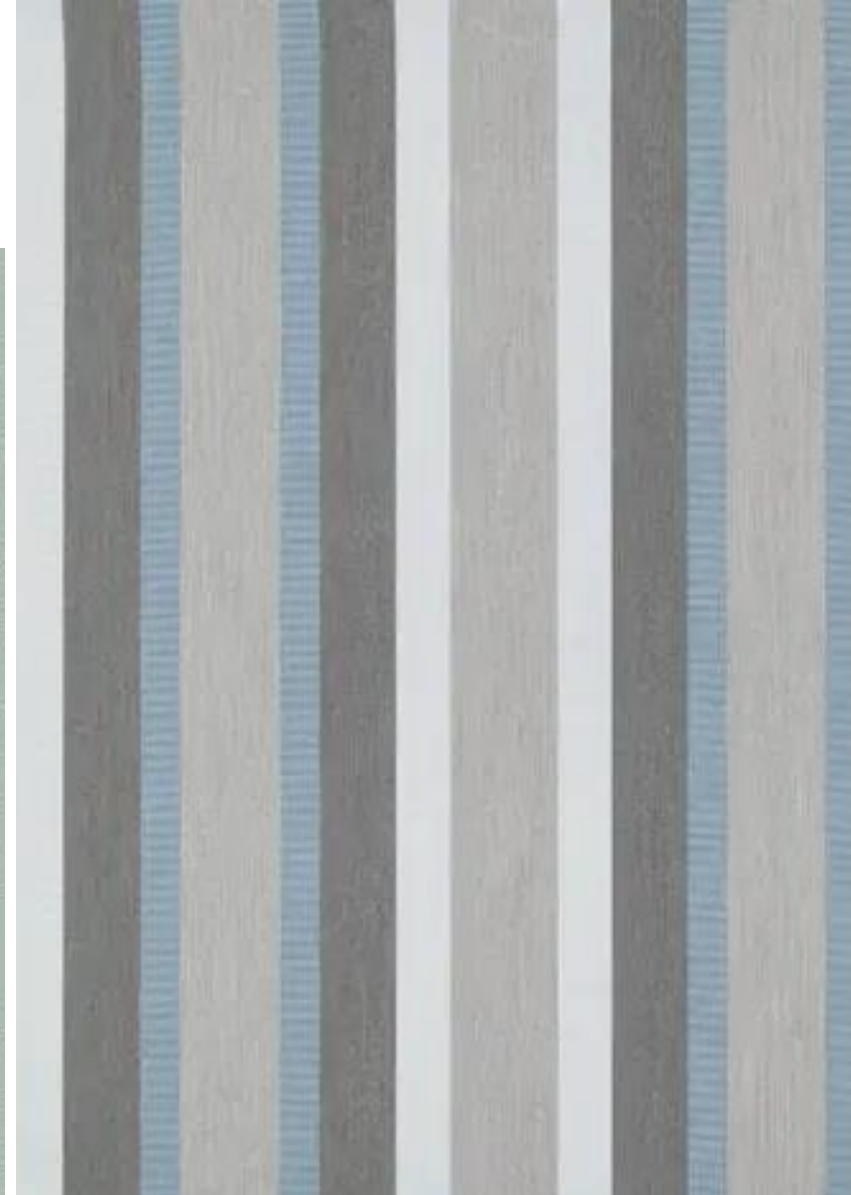
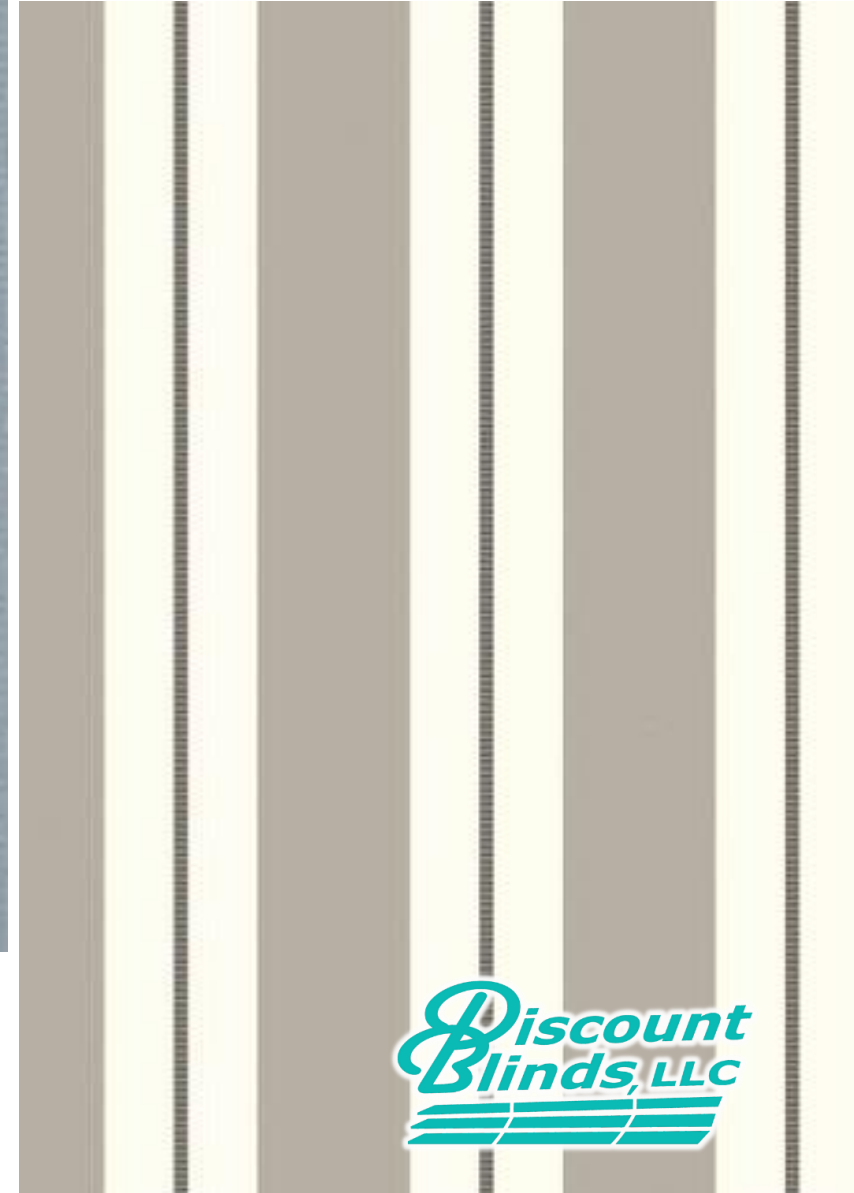

**Marco Blue Grey**





**Hogan Sparrow**

**Hogan Carob**

**Hogan Flame**

**Hogan Admiral**

**Smoke**





LIGHT TAN / BEIGES



EQUATE CASHMERE  
4709-0000



SILICA DUNE  
4859-0000



LINEN  
4633-0000



GREY BEIGE CHIP FANCY  
4777-0000



PUTTY REGIMENTAL  
4961-0000



WESTFIELD MUSHROOM  
4817-0000



TRESKO BIRCH  
4696-0000



SILICA SILVER  
4862-0000



HOGAN SPARROW  
14615-0000

BLUES



MARINE BLUE  
4678-0000



SAXON CASCADE  
4884-0000



NAVY TAUPE FANCY  
4916-0000



COLONNADE SEAGLASS  
4823-0000

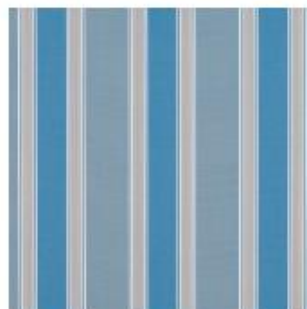

BAYCREST SKY  
4992-0000



CAPTAIN NAVY NATURAL CLASSIC  
4902-0000



HOGAN ADMIRAL  
14613-0000



MARCO BLUE GREY  
4704-0000



RECOMMENDED AS AN  
EFFECTIVE UV PROTECTANT



GREENGUARD  
GOLD

Sunbrella® is a registered trademark of  
Glen Raven, Inc.

REDS / BROWNS



HAVELOCK BRICK  
4985-0000



HOGAN FLAME  
14617-0000



HOGAN CAROB  
14616-0000

GREENS



FOREST GREEN BEIGE  
NATURAL FANCY STRIPE  
4932-0000

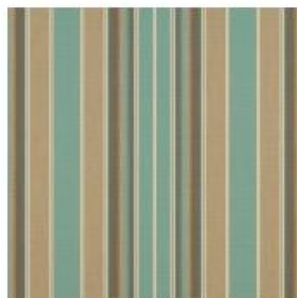

KIAWAH SPA  
4868-0000



PAXTON DEW  
4712-0000

BLACKS / GREYS



SILICA GRAVEL  
4833-0000



CLINTON GRANITE  
4888-0000



SILICA STONE  
4861-0000



SMOKE  
4615-0000



BLACK  
4608-0000



COOPER ASH  
4835-0000



COOPER BLACK  
4988-0000



RECOMMENDED AS AN  
EFFECTIVE UV PROTECTANT



GREENGUARD  
GOLD

Sunbrella® is a registered trademark of  
Glen Raven, Inc.





Straight



Sea Wave

VALANCE TYPE



# MOTOR TYPE

**DOOYA**<sup>®</sup>  
TUBULAR MOTOR

- Available up to 29'11" – 50nm with manual override and LED connection. (This motor has manual limits). Most affordable/ dependable option. Includes 16' electrical cable and remote.

**somfy**<sup>®</sup>

1. Somfy Sunea RTS CMO 535A2 Motor – Designed for Awnings under 20'. Includes Somfy Light Kit Dimming LED RTS 12V Receiver. **\$300 Up Charge**.
2. Somfy Sunea RTS CMO 550R2 Motor – Designed for Awnings up to 29'11". Includes Somfy Light Kit Dimming LED RTS 12V Receiver. **\$325 Up Charge**.
3. Somfy/ Simu 2007156 – DM16Hz 100nm 14rpm Motor for all Awnings over 30'. Includes Somfy Light Kit Dimming LED RTS 12V Receiver.
  - Must purchase Somfy Multi-channel Remote
  - 18' electrical cable included



# MOTOR TYPE — (CONTINUED)

- Where should the motor be installed? Facing awning mounted on wall – Left or Right.
- Do you need extra remotes? Dooya – 1<sup>st</sup> is no charge. Somfy, choose # when ordering remote.
- **Do you need Home Automation?**
  - BOND Bridge
  - BOND Bridge Pro
  - Dooya – DD7002B Multi Link
  - Somfy – MyLink 1811403 or Somfy Tahoma



**DOOYA**<sup>®</sup>  
TUBULAR MOTOR

**somfy**<sup>®</sup>



 **bond** Bridge

# NEW DOOYA MULTI-CHANNEL AWNING REMOTE

- 15 Channel Remote WITH Light Control!





# OPTIONS

- Wind Sensor? – Dooya or Somfy Vibration Sensor
- Drop Screen? – Pre-Manufactured in 4 Standard Sizes 10', 12', 16' & 20'. No color options. Screen is similar to Black Suntex 95. Hardware is Black. 54" Drop
  - Do you need a cut down? \$100 Up charge to cut down one of the 4 Standard Sizes to Custom Size.
- Do you need an extension cord? 10', 15', 20' or 25' Available. Single receptacle- White.
- Hand Crank Size
  - 60" (5') Provided at no charge
  - 72" (6')
  - 102" (8'6")

# Awning Mounting

Wall Mount

Roof Mount

Soffit Mount

Bay Mount



# *BRACKETS - STANDARD*

- How many Standard Brackets? Pre-populated with recommended standard brackets at no additional charge.
- How many extra Standard Brackets?
- Brackets placed within 18" from shoulder





# *BRACKETS - ROOF MOUNTED*



*Standard Brackets are required to be used  
in Conjunction with all Specialty Brackets*



# *BRACKETS - SOFFIT*



***Standard Brackets are required to be used  
in Conjunction with all Specialty Brackets***





# *BRACKETS — BAY MOUNT (CUSTOM BUILT)*



*Standard Brackets are required to be used  
in Conjunction with all Specialty Brackets*



# RETRACTABLE AWNING ACCESSORIES

- Wind Poles
- Replacement LED Strips
- Plastic End Caps
- Plastic Arms Stops
- Touch up paint
- 6' x 4' Fully Operational Demo Awning
- More...

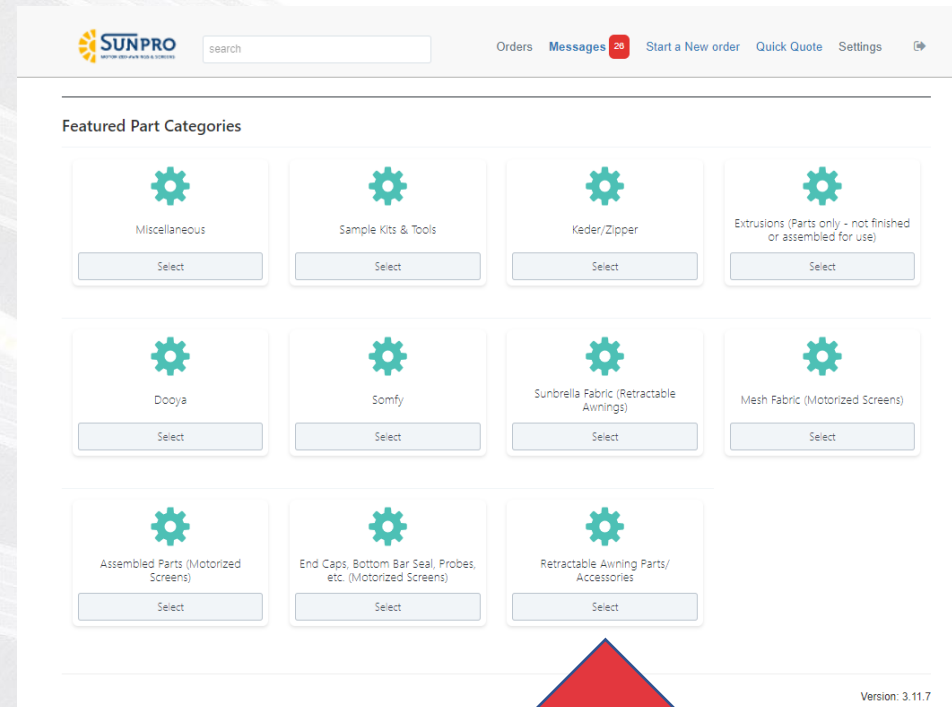

The screenshot shows the SUNPRO website interface. At the top, there is a navigation bar with the SUNPRO logo, a search bar, and links for Orders, Messages (with a red notification badge), Start a New order, Quick Quote, and Settings. Below the navigation bar is a section titled "Featured Part Categories" which contains a grid of 12 category cards. Each card features a green gear icon, a category name, and a "Select" button. The categories are: Miscellaneous, Sample Kits & Tools, Keder/Zipper, Extrusions (Parts only - not finished or assembled for use), Dooya, Somfy, Sunbrella Fabric (Retractable Awnings), Mesh Fabric (Motorized Screens), Assembled Parts (Motorized Screens), End Caps, Bottom Bar Seal, Probes, etc. (Motorized Screens), and Retractable Awning Parts/Accessories. A large red arrow points to the "Retractable Awning Parts/Accessories" category. In the bottom right corner of the screenshot, the text "Version: 3.11.7" is visible.

# AWNING RECOVER

- We make recovers for any awning, regardless of Manufacturer.
- Measure exact width of fabric. Not Hardware. (Follow instructions on Product Wizard)
- Measure Projection – Ok to estimate more. Extra fabric will just be on roll tube.

The screenshot displays the SunPro website interface for a 'Test Recover Order'. The top navigation bar includes the SunPro logo, a search bar, and links for 'Orders', 'Messages' (with a red notification badge), 'Start a New order', 'Quick Quote', and 'Settings'. Below the navigation, the page title is 'PO#: Test Recover Order'. The main content area is titled 'Product Wizard' and prompts the user to 'Select a product or category below'. A 'Featured Products' section is visible, with a red arrow pointing to the 'Awning Recover (for Retractable Awnings)' product. To the right, a detailed configuration form for 'Configure Awning Recover (for Retractable Awnings)' is shown, with another red arrow pointing to it. The form includes a 'Review' button and a 'Fractions' dropdown menu. The version number 'Version: 3.11.7' is located at the bottom right of the page.



# SPECIAL 2023 AWNING PROMOTION!

www.SunProAwnings.com



In celebration of the February grand opening of our new SunPro Retractable Awning Manufacturing Facility, the SunPro team announces a SunPro Special 2023 Spring Awning Promotion for all SunPro Dealers! With SunPro's rapid growth, we have moved all of our awning manufacturing over to a 35,000 sf dedicated facility. This will allow continued expansion of our awning business for years to come.

## OFFER

For every awning ordered by a SunPro Dealer from **NOW through May 31<sup>st</sup>**, SunPro will provide a **free Wind Sensor\***. Additionally, SunPro will offer the **Front Drop Screen at 50% off of our normal dealer price\***. This promotion allows our dealers to discount or include these key add-on accessories at no additional cost, or at a reduced cost to the customer.



\* Wind Sensor or Front Drop Screen must be chosen on the configurator at time of awning order in order to receive promotion. (Effective dates of promotion 2/20/23-5/31/23)

When you combine this Special Offer with our other incredible SunPro Awning Features, you can offer your customers the absolute **BEST VALUE** in the Retractable Awning Industry!

- Choice of 30 in-stock Sunbrella® Fabrics included at no additional charge. The top awning fabric in the world. (See our Why Sunbrella®? fact sheet). The SunPro 30 Sunbrella® Colors are the best selling/ most popular colors in the awning industry! Compared to other manufacturers who upcharge for Sunbrella®, why limit your customer's fabric choices with inferior fabrics and outdated selections? We are upgrading those SunPro 30 in-stock Sunbrella® fabric colors this year with 8 new incredible choices. More to follow... Use the special SunPro version of Sunbrella's® Shade Studio to help your customer visualize what an awning made with Sunbrella® fabric could look like on their home. <https://shadestudio.sunbrella.com/sunpro/>
- SunPro's highly skilled fabric department takes the Sunbrella® Fabric and creates the best awning cover in the industry. We start the panels in the center and work out the seams so they're evenly spaced. All outside edges are double stitched with Tenara® thread for years of durability. Compared to companies that pre-build awnings and cut down fabrics to match the size after the fact, the difference in quality and aesthetics is substantial!



www.SunProAwnings.com



- All SunPro Awnings are Custom Made and individually manufactured to the inch (from 9'6" wide up to 40' wide) specifically for your customer. Completely manufactured in Bradenton Florida. **MADE IN THE USA!** No cut down charges—made specifically for your customer.
- Wind Sensor Included at no additional charge. **\$300.00 VALUE** to the consumer
- LED (dimnable) lights Built-in to the Awning Arms at no additional charge. **\$400.00 VALUE** to the consumer.
- Front Drop Screen at 50% Off. **\$300.00 VALUE** to the consumer.
- Motorized Operation (with manual override) on all SunPro Awnings, with one remote control to extend or retract your awning + control the LED dimmable Lights.
- EZ Adjustable Pitch allows the consumer to adjust the angle of their awning quickly and with little effort (and no dealer service calls) at no additional charge.
- All SunPro Awnings include a corrosion free and powder-coated aluminum cassette housing at no additional charge to protect the fabric. Other manufacturers charge for a hood (carport) to house the fabric as an expensive add on. Our cassette is more like a garage than a carport to protect the fabric.

Additionally, all of these features come with the SunPro Advantage for choosing us as your manufacturer:

#1 IN DEALER SATISFACTION	#1 IN TURN AROUND TIME	#1 IN QUALITY	#1 IN TRANSPORTATION	#1 IN INNOVATION
Our dealers stay with us for the long term. We have virtually zero dealer turnover. We know we need to earn your business everyday and we work hard at doing just that.	Fastest turnaround time in the industry. Period. No one comes close. Awnings are typically custom made in under a week.	We continue to invest heavily in training, adding new equipment, improving our processes and focusing on quality every day. All Awnings are completely assembled and tested prior to shipment. Even the Wind Sensor is programmed. Cuts down on your installation time and expense.	We hand-deliver over 90% of our dealers with company trucks and company employees at a minimal price. All awnings up to 40' wide are delivered as one unit. No assembly at the job site. Essentially no shipping damage!	We always have new products in the pipeline and we are committed to leading the industry in products that our dealers need to dominate their markets. We are continually gathering dealer/ installer feedback and improving our products and processes.



SunPro was ranked as one of AMERICA'S FASTEST-GROWING PRIVATE COMPANIES

This promotion will be reflected on your order configurator at <https://app.sunproproducts.com> on Monday morning 2/20/23.



## Warranty At A Glance

### Roll Screens

- Hardware LIFETIME
- Motors / Controls 5 Years
- Fabric / Mesh 2,5,10,15 Year

### Awnings

- Hardware LIFETIME
- Motors 10 Years
- Fabric 10 Years
- Accessories 2 Years



# Recommended Tools

- Circular Saw
- Diablo Aluminum Blade
- Drill
- Hammer Drill
- Impact Driver
- Grinder
- Oscillating Tool
- Vacuum
- Batteries
- Battery Charger
- Ladders
- Levels (Torpedo, 4', 6')
- Tape Measure
- Speed Square
- String
- Saw Horses
- Utility Knife
- T-25 Torx Bit
- Concrete Drill Bits
- Regular Drill Bits
- 12" Drill Bits (1/4 & 3/8)
- Impact Driver Bit Set
- 6" 1/4, 5/16, 3/8 Nut Driver Bits
- 3/8 Drive Socket Adapter for Impact
- Needle Nose Pliers
- Wire Cutters/ Strippers
- Extension Cords
- Caulk Gun
- Deep Well Socket Set
- Wrench Set
- Swage Crimpers
- Cable Cutters